

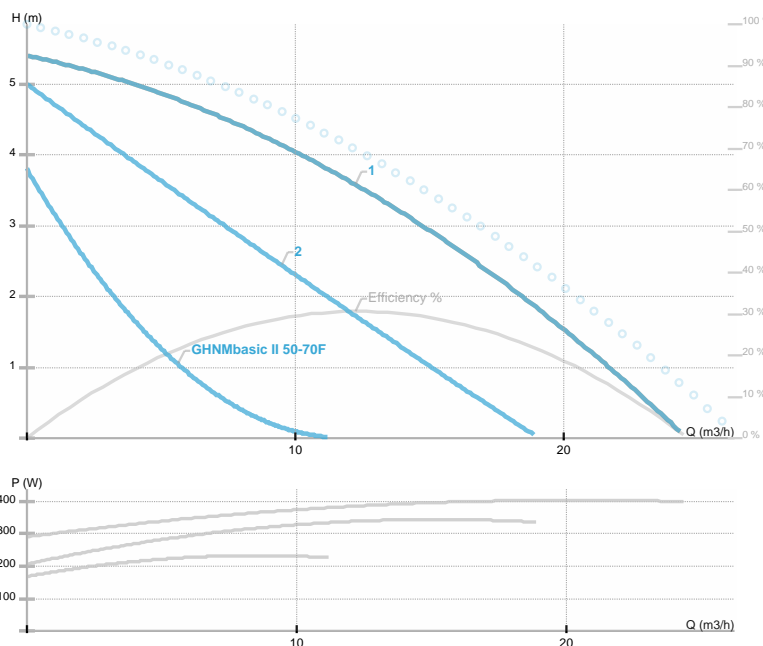

GHNbasic II 50-70F

GHNbasic / Circolatore flangiato a tre velocita' MONOFASE
 Riscaldamento



Codice articolo	979524501
Alimentazione	1~230V, 50Hz
Classe di protezione	IP44
Q max	24.5 [m³/h]
H max	5.4 [m]
Giri/min	[1/min]
Potenza motore	405 [w]
Corrente nominale	1.85 [A]
Fluidi consentiti	Water VDI 2035, glycol 50%
Temperatura fluido	-10.0 ÷ 120.0 [°C]
Classe di isolamento	200
DN1	50 [mm]
Connettore	PN 6/10
Peso	36,40 [kg]
Interasse	280 [mm]
Certificazioni	EAC
EEL	
Efficienza	[%]
Materiale girante	AISI 304
Materiale cuscinetti	Graphite
Materiale albero	AISI 431
Material corpo pompa	Ghisa
Frequenza	50 Hz
Connection	PN 6/10
Pressione massima	
Temperatura max. ambiente	40 deg C

Disegno 1

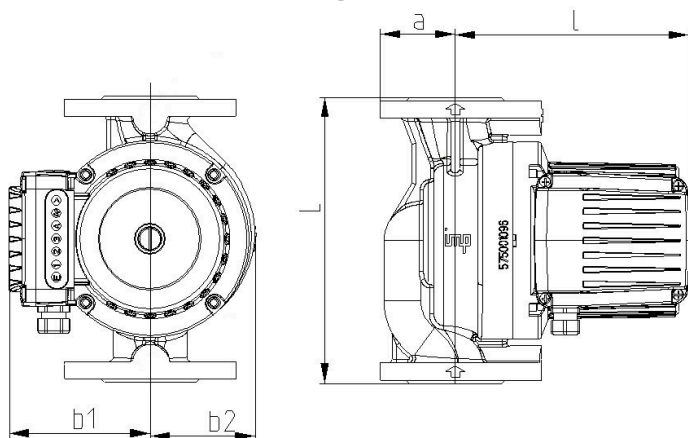

DN=50 L=280 a=70 l=220 b1=130 b2=123 R=1/4

Schema

