



THREADED FITTINGS

/ RACCORDI FILETTATI
/ GEWINDEFITTINGS
/ RACCORDS FILETÉS

THREADED FITTINGS

/ RACCORDI FILETTATI
/ GEWINDEFITTINGS
/ RACCORDS FILETÉS



THREADED FITTINGS

BRASS THREADED FITTINGS SAND-BLASTED	100
THREADED FITTINGS WITH SWIVEL NUT SAND-BLASTED	106
THREADED FITTINGS 3 PCS	108
EXTENSIONS	110
THREADED FITTINGS NICKEL-PLATED	116
3THREADED FITTINGS NICKEL-PLATED 3 PCS	119
THREADED FITTINGS CHROME-PLATED	120

BRASS THREADED FITTINGS SAND-BLASTED

BRASS





 UNI EN 12164/12165
 CW 617N
 DIN 50930-6

 / RACCORDI FILETTATI SABBATI
 / GEWINDEFITTINGE SANDGESTRAHLT
 / RACCORDS FILETÉS SABLÉS

MALE/MALE STRAIGHT COUPLER

 / RACCORDO DIRITTO MASCHIO/MASCHIO
 / KUPPLUNG AG/AG
 / MANCHON MÂLE/MÂLE

270A



CODE	TECH. CODE	SIZE 		
77.01.050	RF0270A03000	3/8" x 3/8" (Ø int. mm 10 - fil. mm 8)	10	400
77.01.051	RF0270A05000	1/2" x 1/2" (Ø int. mm 14 - fil. mm 9)	10	300
77.01.060	RF0270A05140	1/2" x 1/2" (Ø int. mm 14 - fil. mm 11)	10	200
77.01.014	RF0270A07000	3/4" x 3/4" (Ø int. mm 19 - fil. mm 10)	10	150
77.01.061	RF0270A07190	3/4" x 3/4" (Ø int. mm 19 - fil. mm 12)	10	150
77.01.052	RF0270A10000	1" x 1"	10	100
77.01.053	RF0270A12000	1 1/4" x 1 1/4"	10	60
77.01.054	RF0270A15000	1 1/2" x 1 1/2"	5	40
77.01.055	RF0270A20000	2" x 2"	5	25

HEAVY PATTERN SERIES

MALE/MALE REDUCING COUPLER

 / RACCORDO DIRITTO RIDOTTO
 MASCHIO/MASCHIO
 / REDUZIERNIPPEL AG/AG
 / MANCHON RÉDUIT MÂLE/MÂLE



291

CODE	TECH. CODE	SIZE 		
77.02.005	RF0291002010	1/4" x 1/8"	10	300
77.02.010	RF0291003020	3/8" x 1/4"	10	300
77.02.080	RF0291005030	1/2" x 3/8"	10	300
77.02.081	RF0291007050	3/4" x 1/2"	10	200
77.02.026	RF0291010050	1" x 1/2"	5	120
77.02.082	RF0291010070	1" x 3/4"	10	120
77.02.035	RF0291012050	1 1/4" x 1/2"		30
77.02.040	RF0291012070	1 1/4" x 3/4"		20
77.02.083	RF0291012100	1 1/4" x 1"	10	80
77.02.045	RF0291015070	1 1/2" x 3/4"		35
77.02.050	RF0291015100	1 1/2" x 1"		30
77.02.084	RF0291015120	1 1/2" x 1 1/4"	5	40
77.02.060	RF0291020100	2" x 1"		20
77.02.065	RF0291020120	2" x 1 1/4"		20
77.02.085	RF0291020150	2" x 1 1/2"		25

MALE/FEMALE REDUCTION

 / RIDUZIONE MASCHIO/FEMMINA
 / REDUZIERTSTÜCK AG/IG
 / RÉDUCTION MÂLE/FEMELLE

287



CODE	TECH. CODE	SIZE 		
77.14.170	RF0287002010	1/4" M x 1/8" F	10	500
77.14.171	RF0287003020	3/8" M x 1/4" F	10	500
77.14.172	RF0287005010	1/2" M x 1/8" F	10	400
77.14.173	RF0287005020	1/2" M x 1/4" F	10	400
77.14.174	RF0287005030	1/2" M x 3/8" F	10	400
77.14.105	RF0287007030	3/4" M x 3/8" F	10	150
77.14.175	RF0287007050	3/4" M x 1/2" F	10	300
77.14.177	RF0287010050	1" M x 1/2" F	10	200
77.14.178	RF0287010070	1" M x 3/4" F	10	200
77.14.125	RF0287012050	1 1/4" M x 1/2" F		50
77.14.179	RF0287012070	1 1/4" M x 3/4" F	10	100
77.14.180	RF0287012100	1 1/4" M x 1" F	10	100
77.14.181	RF0287015070	1 1/2" M x 3/4" F	10	70
77.14.182	RF0287015100	1 1/2" M x 1" F	10	70
77.14.183	RF0287015120	1 1/2" M x 1 1/4" F	10	70
77.14.155	RF0287020100	2" M x 1" F		30
77.14.160	RF0287020120	2" M x 1 1/4" F		30
77.14.184	RF0287020150	2" M x 1 1/2" F		30

MALE/FEMALE REDUCTION WITH FLANGE

/ RIDUZIONE MASCHIO/FEMMINA
CON FLANGIA
/ REDUZIERTSTÜCK AG/IG MIT FLANSCH
/ RÉDUCTION MÂLE/FEMELLE
AVEC BRIDE D'ARRÊT



285



CODE	TECH. CODE	SIZE 		
77.14.020	RF0285007030	3/4" M x 3/8" F	10	150
77.14.025	RF0285007050	3/4" M x 1/2" F	10	150
77.14.030	RF0285010050	1" M x 1/2" F	5	100
77.14.035	RF0285010070	1" M x 3/4" F	5	100
77.14.040	RF0285012050	1 1/4" M x 1/2" F		50
77.14.045	RF0285012070	1 1/4" M x 3/4" F		50
77.14.050	RF0285012100	1 1/4" M x 1" F		50
77.14.060	RF0285015070	1 1/2" M x 3/4" F		30
77.14.065	RF0285015100	1 1/2" M x 1" F		30

FEMALE/FEMALE STRAIGHT COUPLER

/ RACCORDO DIRITTO FEMMINA/FEMMINA
/ MUFFE IG/IG
/ MANCHON FEMELLE/FEMELLE



270F



CODE	TECH. CODE	SIZE 		
77.03.040	RF0270F02000	1/4" x 1/4"	10	500
77.03.041	RF0270F03000	3/8" x 3/8"	10	300
77.03.046	RF0270F05000	1/2" x 1/2"	10	200
77.03.047	RF0270F07000	3/4" x 3/4"	10	100
77.03.042	RF0270F10000	1" x 1"	10	70
77.03.043	RF0270F12000	1 1/4" x 1 1/4"	10	40
77.03.044	RF0270F15000	1 1/2" x 1 1/2"	5	20
77.03.045	RF0270F20000	2" x 2"	5	15

FEMALE/FEMALE STRAIGHT COUPLER

/ RACCORDO DIRITTO FEMMINA/FEMMINA
/ MUFFE IG/IG
/ MANCHON FEMELLE/FEMELLE



274



CODE	TECH. CODE	SIZE 		
77.03.005	RF0274003000	3/8" x 3/8"	10	200
77.03.010	RF0274005000	1/2" x 1/2"	10	200
77.03.015	RF0274007000	3/4" x 3/4"	10	100
77.03.020	RF0274010000	1" x 1"	5	100
77.03.025	RF0274012000	1 1/4" x 1 1/4"		10
77.03.030	RF0274015000	1 1/2" x 1 1/2"		20
77.03.035	RF0274020000	2" x 2"		10

FEMALE/FEMALE REDUCING COUPLER

/ RACCORDO DIRITTO RIDOTTO
FEMMINA/FEMMINA
/ MUFFE IG/IG REDUZIERT
/ MANCHON RÉDUIT FEMELLE/FEMELLE



294



CODE	TECH. CODE	SIZE 		
77.03.091	RF0294007050	3/4" x 1/2"	10	120
77.03.092	RF0294010050	1" x 1/2"	10	70
77.03.093	RF0294010070	1" x 3/4"	10	70
77.03.094	RF0294012100	1 1/4" x 1"	5	40

FEMALE REDUCING COUPLER

/ RACCORDO DIRITTO RIDOTTO
FEMMINA/FEMMINA
/ MUFFE IG/IG REDUZIERT
/ MANCHON RÉDUIT FEMELLE/FEMELLE



296



CODE	TECH. CODE	SIZE 		
77.03.050	RF0296005030	1/2" x 3/8"	10	200
77.03.055	RF0296007050	3/4" x 1/2"	10	100
77.03.060	RF0296010050	1" x 1/2"	5	100
77.03.065	RF0296010070	1" x 3/4"	5	50
77.03.070	RF0296012050	1 1/4" x 1/2"		30
77.03.075	RF0296012070	1 1/4" x 3/4"		30
77.03.080	RF0296012100	1 1/4" x 1"		30
77.03.085	RF0296015100	1 1/2" x 1"		30
77.03.090	RF0296015120	1 1/2" x 1 1/4"		20

FEMALE/MALE REDUCING COUPLER

/ RACCORDO DIRITTO RIDOTTO
FEMMINA/MASCHIO
/ MUFFE IG/AG REDUZIERT
/ MANCHON RÉDUIT FEMELLE/MÂLE



295



CODE	TECH. CODE	SIZE 		
77.04.035	RF0295005020	1/2" F x 1/4" M	10	150
77.04.073	RF0295005030	1/2" F x 3/8" M	10	250
77.04.070	RF0295007050	3/4" F x 1/2" M	10	150
77.04.071	RF0295010050	1" F x 1/2" M	10	80
77.04.072	RF0295010070	1" F x 3/4" M	10	80
77.04.045	RF0295012050	1 1/4" F x 1/2" M		30
77.04.050	RF0295012070	1 1/4" F x 3/4" M		30
77.04.055	RF0295012100	1 1/4" F x 1" M		30
77.04.060	RF0295015100	1 1/2" F x 1" M		30
77.04.065	RF0295015120	1 1/2" F x 1 1/4" M		20

MALE/MALE ELBOW 90°

/ GOMITO 90° MASCHIO/MASCHIO
/ WINKEL 90° AG/AG
/ COUDE 90° MÂLE/MÂLE



260A



CODE	TECH. CODE	SIZE 		
77.07.035	RF0260A01000	1/8" x 1/8"	10	500
77.07.036	RF0260A02000	1/4" x 1/4"	10	400
77.07.037	RF0260A03000	3/8" x 3/8"	10	300
77.07.038	RF0260A05000	1/2" x 1/2"	10	200
77.07.039	RF0260A07000	3/4" x 3/4"	10	120
77.07.040	RF0260A10000	1" x 1"	10	50
77.07.041	RF0260A12000	1 1/4" x 1 1/4"		25
77.07.042	RF0260A15000	1 1/2" x 1 1/2"		20
77.07.043	RF0260A20000	2" x 2"		15

FEMALE/FEMALE ELBOW 90°

/ GOMITO 90° FEMMINA/FEMMINA
/ WINKEL 90° IG/IG
/ COUDE 90° FEMELLE/FEMELLE



260F



CODE	TECH. CODE	SIZE 		
77.05.040	RF0260F02000	1/4" x 1/4"	10	300
77.05.041	RF0260F03000	3/8" x 3/8"	10	200
77.05.042	RF0260F05000	1/2" x 1/2"	10	130
77.05.043	RF0260F07000	3/4" x 3/4"	10	70
77.05.044	RF0260F10000	1" x 1"	5	40
77.05.045	RF0260F12000	1 1/4" x 1 1/4"		20
77.05.046	RF0260F15000	1 1/2" x 1 1/2"		20
77.05.047	RF0260F20000	2" x 2"		15

FEMALE/MALE ELBOW 90°

/ GOMITO 90° FEMMINA/MASCHIO
/ WINKEL 90° IG/AG
/ COUDE 90° FEMELLE/MÂLE



262A

CODE	TECH. CODE	SIZE 		
77.06.035	RF0262A02000	1/4" x 1/4"	10	300
77.06.036	RF0262A03000	3/8" x 3/8"	10	200
77.06.037	RF0262A05000	1/2" x 1/2"	10	120
77.06.038	RF0262A07000	3/4" x 3/4"	10	40
77.06.039	RF0262A10000	1" x 1"	10	40
77.06.040	RF0262A12000	1 1/4" x 1 1/4"		25
77.06.041	RF0262A15000	1 1/2" x 1 1/2"		20
77.06.042	RF0262A20000	2" x 2"		15



HEAVY PATTERN SERIES

MALE/MALE ELBOW 90° WITH FLANGE - HP SERIES

/ GOMITO 90° MASCHIO/MASCHIO
CON FLANGIA - SERIE HP
/ WINKEL 90° AG/AG MIT FLANSCH -
HP SERIE
/ COUDE 90° MÂLE/MÂLE
AVEC BRIDE D'ARRÊT - HP SERIES



266



CODE	TECH. CODE	SIZE 		
77.07.020	RF0266005000	1/2" x 1/2"	10	100
77.07.025	RF0266007000	3/4" x 3/4"	10	60
77.07.030	RF0266010000	1" x 1"	5	40

MALE/FEMALE ELBOW 90° WITH FLANGE - HP SERIES

/ GOMITO 90° MASCHIO/FEMMINA
CON FLANGIA - SERIE HP
/ WINKEL 90° AG/IG MIT FLANSCH -
HP SERIE
/ COUDE 90° MÂLE/FEMELLE
AVEC BRIDE D'ARRÊT - HP SERIE



267



CODE	TECH. CODE	SIZE 		
77.06.020	RF0267005000	1/2" x 1/2"	10	100
77.06.025	RF0267007000	3/4" x 3/4"	10	100
77.06.030	RF0267010000	1" x 1"	5	50

MALE/FEMALE ELBOW 90° WITHOUT FLANGE - HP SERIES

/ GOMITO 90° MASCHIO/FEMMINA
SENZA FLANGIA - SERIE HP
/ WINKEL 90° AG/IG OHNE FLANSCH - HP SERIE
/ COUDE 90° MÂLE/FEMELLE
SANS BRIDE D'ARRÊT - HP SERIE



269



CODE	TECH. CODE	SIZE 		
77.06.015	RF0269005000	1/2" x 1/2"	10	100
77.06.016	RF0269007000	3/4" x 3/4"	10	60
77.06.017	RF0269010000	1" x 1"	5	50

FEMALE/MALE REDUCING ELBOW 90°

/ GOMITO 90° RIDOTTO FEMMINA/MASCHIO
/ WINKEL 90° IG/AG REDUZIERT
/ COUDE RÉDUIT 90° FEMELLE/MÂLE



262B

CODE	TECH. CODE	SIZE 		
77.06.050	RF0262B05030	1/2" F x 3/8" M	10	150
77.06.051	RF0262B07050	3/4" F x 1/2" M	10	100

MALE TEE

/ RACCORDO A T MASCHIO
/ T-STÜCK MIT AG
/ TÉ MÂLE



250A

CODE	TECH. CODE	SIZE 		
77.07.091	RF0250A01000	1/8" x 1/8" x 1/8"	10	250
77.07.092	RF0250A02000	1/4" x 1/4" x 1/4"	10	250
77.07.093	RF0250A03000	3/8" x 3/8" x 3/8"	10	200
77.07.094	RF0250A05000	1/2" x 1/2" x 1/2"	10	120
77.07.095	RF0250A07000	3/4" x 3/4" x 3/4"	10	80
77.07.096	RF0250A10000	1" x 1" x 1"	5	40
77.07.097	RF0250A12000	1 1/4" x 1 1/4" x 1 1/4"		15
77.07.098	RF0250A15000	1 1/2" x 1 1/2" x 1 1/2"		15
77.07.099	RF0250A20000	2" x 2" x 2"		15



HEAVY PATTERN SERIES

MALE TEE - HP SERIES

/ RACCORDO A T MASCHIO - SERIE HP
/ T-STÜCK MIT AG - HP SERIE
/ TÉ MÂLE - HP SERIE



255



CODE	TECH. CODE	SIZE 		
77.07.080	RF0255005000	1/2" x 1/2" x 1/2"	10	120
77.07.085	RF0255007000	3/4" x 3/4" x 3/4"	10	60
77.07.090	RF0255010000	1" x 1" x 1"	5	30

FEMALE REDUCING TEE

/ RACCORDO A T RIDOTTO FEMMINA
/ T-STÜCK REDUZIERT IG
/ TÉ RÉDUIT FEMELLE



253F



CODE	TECH. CODE	SIZE 		
77.08.050	RF0253F07050	3/4" x 1/2" x 3/4"	10	50
77.08.055	RF0253F10050	1" x 1/2" x 1"	5	30
77.08.060	RF0253F10070	1" x 3/4" x 1"	5	30

FEMALE TEE

/ RACCORDO A T FEMMINA
/ T-STÜCK MIT IG
/ TÉ FEMELLE



250F



CODE	TECH. CODE	SIZE 		
77.08.037	RF0250F02000	1/4" x 1/4" x 1/4"	10	200
77.08.038	RF0250F03000	3/8" x 3/8" x 3/8"	10	150
77.08.039	RF0250F05000	1/2" x 1/2" x 1/2"	10	80
77.08.040	RF0250F07000	3/4" x 3/4" x 3/4"	10	50
77.08.041	RF0250F10000	1" x 1" x 1"	5	25
77.08.042	RF0250F12000	1 1/4" x 1 1/4" x 1 1/4"		15
77.08.043	RF0250F15000	1 1/2" x 1 1/2" x 1 1/2"		15
77.08.044	RF0250F20000	2" x 2" x 2"		15

MALE/FEMALE/MALE REDUCING TEE

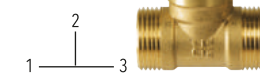
/ RACCORDO A T RIDOTTO
MASCHIO/FEMMINA/MASCHIO
/ T-STÜCK REDUZIERT AG/IG/AG
/ TÉ RÉDUIT MÂLE/FEMELLE/MÂLE



950



CODE	TECH. CODE	SIZE 		
77.08.065	RF0950007050	3/4" x 1/2" x 3/4"	10	70

FEMALE/MALE/MALE REDUCING TEE

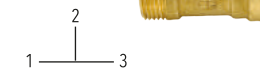
/ RACCORDO A T RIDOTTO
FEMMINA/MASCHIO/MASCHIO
/ T-STÜCK REDUZIERT IG/AG/AG
/ TÉ RÉDUIT FEMELLE/MÂLE/MÂLE



935



CODE	TECH. CODE	SIZE 		
77.08.070	RF0935007050	1/2" x 3/4" x 3/4"	10	70

MALE/MALE ELBOW 90°

/ GOMITO 90° MASCHIO/MASCHIO
/ WINKEL 90° AG/AG
/ COUDE 90° MÂLE/MÂLE



268



CODE	TECH. CODE	SIZE 		
77.07.050	RF0268005000	1/2" x 1/2"	10	100

FEMELLE/FEMELLE WALLPLATE ELBOW 90°

/ GOMITO 90° FLANGIATO
FEMMINA/FEMMINA
/ WANDWINKEL 90° IG/IG
/ APPLIQUE MURALE 90° FEMELLE/FEMELLE



264F



CODE	TECH. CODE	SIZE 		
77.08.100	RF0264F05000	1/2" x 1/2"	10	100

NUT

/ DADO
/ MUTTER
/ ÉCROU



174



CODE	TECH. CODE	SIZE 		
77.12.102	DC0174005100	1/2" x 10	10	600
77.12.103	DC0174005120	1/2" x 12	10	600
77.12.104	DC0174005140	1/2" x 14	10	600
77.12.105	DC0174005160	1/2" x 16	10	600
77.12.106	DC0174007140	3/4" x 14	10	400
77.12.107	DC0174007160	3/4" x 16	10	400
77.12.108	DC0174007180	3/4" x 18	10	400
77.12.109	DC0174007200	3/4" x 20	10	250
77.12.110	DC0174007220	3/4" x 22	10	350

MALE CAP

/ TAPPO MASCHIO
/ STOPFEN AG
/ BOUCHON MÂLE



286



CODE	TECH. CODE	SIZE 		
77.13.043	RF0286003000	3/8"	10	400
77.13.044	RF0286005000	1/2"	10	400
77.13.045	RF0286007000	3/4"	10	150
77.13.046	RF0286010000	1"	10	150
77.13.047	RF0286012000	1 1/4"	10	80
77.13.048	RF0286015000	1 1/2"	10	60
77.13.049	RF0286020000	2"	5	40

FEMALE CAP

/ TAPPO FEMMINA
/ KAPPE IG
/ BOUCHON FEMELLE



288



CODE	TECH. CODE	SIZE 		
77.12.005	RF028800200L	1/4"	10	400
77.12.006	RF028800300L	3/8"	10	400
77.12.010	RF0288005000	1/2"	10	200
77.12.015	RF0288007000	3/4"	10	200
77.12.020	RF0288010000	1"	5	100
77.12.026	RF0288012000	1 1/4"	10	100
77.12.031	RF0288015000	1 1/2"	5	50
77.12.035	RF0288020000	2"		8

FLANGED BACKNUT

/ CONTRODADO CON FLANGIA
/ GEGENMUTTER MIT FLANSCH
/ CONTRE ÉCROU À PLATEAU



293



CODE	TECH. CODE	SIZE 		
77.12.150	RF0293003000	3/8"	10	400
77.12.151	RF0293005000	1/2"	10	300
77.12.152	RF0293007000	3/4"	10	200
77.12.153	RF0293010000	1"	10	150

FEMALE/MALE EXTENSION

/ PROLUNGA FEMMINA/MASCHIO
/ VERLÄNGERUNG IG/AG
/ RALLONGE FEMELLE/MÂLE





292

CODE	TECH. CODE	SIZE 		
77.15.150	RF0292005100	1/2"-10	10	250
77.15.151	RF0292005150	1/2"-15	10	250
77.15.152	RF0292005200	1/2"-20	10	200
77.15.153	RF0292005250	1/2"-25	10	200
77.15.154	RF0292005300	1/2"-30	10	150

MALE PLUG WITH FLANGE

/ TAPPO MASCHIO CON FLANGIA
/ STOPFEN AG MIT FLANSCH
/ BOUCHON MÂLE AVEC BRIDE D'ARRÊT

**276**

CODE	TECH. CODE	SIZE 		
77.13.040	RF027600500L	1/2"	10	350
77.13.041	RF0276007000	3/4"	10	200
77.13.042	RF0276010000	1"	10	120
77.13.025	RF0276012000	1 1/4"		50
77.13.030	RF0276015000	1 1/2"		50
77.13.035	RF0276020000	2"		30

FITTING FOR BIN WITH CAP

/ RACCORDO PER CASSONE CON TAPPO
/ GERADE VERSCHRAUBUNG MIT KAPPE FÜR
KASTEN
/ RACCORD POUR RÉSERVOIR AVEC
BOUCHON

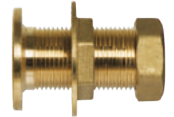

**275**

CODE	TECH. CODE	SIZE 	
77.15.160	RF0275005000	1/2"	50
77.15.161	RF0275007000	3/4"	50
77.15.162	RF0275010000	1"	40

NUT

/ DADO
/ MUTTER
/ ÉCROU



**175**

CODE	TECH. CODE	SIZE 	
77.12.115	DC0175007000	3/4"	250
77.12.116	DC0175010000	1"	250
77.12.117	DC0175012000	1 1/4"	150
77.12.118	DC0175015000	1 1/2"	100

FITTING FOR BIN WITHOUT CAP

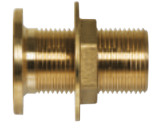
/ RACCORDO PER CASSONE SENZA TAPPO
/ GERADE VERSCHRAUBUNG OHNE KAPPE
FÜR KASTEN
/ RACCORD POUR RÉSERVOIR SANS
BOUCHON



**275-ST**

CODE	TECH. CODE	SIZE 	
77.15.170	RF0275005ST0	1/2"	50
77.15.171	RF0275007ST0	3/4"	50
77.15.172	RF0275010ST0	1"	40
77.15.173	RF0275012ST0	1 1/4"	25
77.15.174	RF0275015ST0	1 1/2"	25
77.15.175	RF0275020ST0	2"	15

FLAT TAIL

/ CODULO PIATTO
/ BUCHSE FLACHDICHTEND
/ DOUILLE PLATE

**172P**

CODE	TECH. CODE	SIZE 	
77.12.095	DC0172P05000	1/2"	400
77.12.096	DC0172P07000	3/4"	300
77.12.097	DC0172P10000	1"	100
77.12.098	DC0172P12000	1 1/4"	100

THREADED FITTINGS WITH SWIVEL NUT SAND-BLASTED

BRASS



UNI EN 12164/12165
CW 617N
DIN 50930-6

/ RACCORDI FILETTATI CON DADO PRIGIONIERO SABBATI
/ GEWINDEFITTINGE MIT ÜBERWURFMUTTER SANDGESTRAHLT
/ RACCORDS FILETÉS AVEC ÉCROU PRISONNIER SABLÉS

TEE MALE/MALE/SWIVEL NUT

/ RACCORDO A T MASCHIO/MASCHIO/
DADO PRIGIONIERO
/ T-STÜCK AG/AG/ÜBERWURFMUTTER
/ TEE MÅLE/MÅLE/ÉCROU PRISONNIER



751

CODE	TECH. CODE	SIZE 		
77.18.310	RF0751007770	3/4" x 3/4" x 3/4"	10	60

TEE MALE/FEMALE/SWIVEL NUT

/ RACCORDO A T MASCHIO/FEMMINA/
DADO PRIGIONIERO
/ T-STÜCK AG/IG/ÜBERWURFMUTTER
/ TEE MÅLE/FEMELLE/ÉCROU PRISONNIER



752



CODE	TECH. CODE	SIZE 		
77.18.315	RF0752007370	3/4" x 3/8" x 3/4"	10	60

TEE FEMALE/MALE/SWIVEL NUT

/ RACCORDO A T FEMMINA/MASCHIO/
DADO PRIGIONIERO
/ T-STÜCK IG/AG/ÜBERWURFMUTTER
/ TEE FEMELLE/MÅLE/ÉCROU PRISONNIER



753

CODE	TECH. CODE	SIZE 		
77.18.330	RF0753005770	1/2" x 3/4" x 3/4"	10	60

TEE MALE/SWIVEL NUT/MALE

/ RACCORDO A T MASCHIO/DADO
PRIGIONIERO/MASCHIO
/ T-STÜCK AG/ÜBERWURFMUTTER/AG
/ TEE MÅLE/ÉCROU PRISONNIER/MÅLE



754

CODE	TECH. CODE	SIZE 		
77.18.320	RF0754007770	3/4" x 3/4" x 3/4"	10	60

TEE SWIVEL NUT/MALE/SWIVEL NUT

/ RACCORDO A T DADO PRIGIONIERO/
MASCHIO/DADO PRIGIONIERO
/ T-STÜCK ÜBERWURFMUTTER/AG/
ÜBERWURFMUTTER
/ TEE ÉCROU PRISONNIER/MÅLE/ÉCROU
PRISONNIER



755

CODE	TECH. CODE	SIZE 		
77.18.335	RF0755007770	3/4" x 3/4" x 3/4"	10	50

TEE MALE/SWIVEL NUT/SWIVEL NUT

/ RACCORDO A T MASCHIO/DADO
PRIGIONIERO/DADO PRIGIONIERO
/ T-STÜCK AG/ÜBERWURFMUTTER
ÜBERWURFMUTTER
/ TEE MÅLE/ÉCROU PRISONNIER/ÉCROU
PRISONNIER



756



CODE	TECH. CODE	SIZE 		
77.18.325	RF0756007770	3/4" x 3/4" x 3/4"	10	50

TEE FEMALE/SWIVEL NUT/SWIVEL NUT

/ RACCORDO A T FEMMINA/DADO
PRIGIONIERO/DADO PRIGIONIERO
/ T-STÜCK IG/ÜBERWURFMUTTER/
ÜBERWURFMUTTER
/ TEE FEMELLE/ÉCROU PRISONNIER/
ÉCROU PRISONNIER



757



CODE	TECH. CODE	SIZE 		
77.18.340	RF0757005770	1/2" x 3/4" x 3/4"	10	50

ELBOW 90° SWIVEL NUT

/ GOMITO 90° DADO PRIGIONIERO
/ WINKEL 90° ÜBERWURFMUTTER
/ COUDE 90° ÉCROU PRISONNIER



761



CODE	TECH. CODE	SIZE 		
77.18.345	RF0761005050	1/2" x 1/2"	10	150
77.18.346	RF0761007070	3/4" x 3/4"	10	70

ELBOW 90° MALE/SWIVEL NUT

/ GOMITO 90° MASCHIO/DADO PRIGIONIERO
/ WINKEL 90° AG/ÜBERWURFMUTTER
/ COUDE 90° MÂLE/ÉCROU PRISONNIER



762



CODE	TECH. CODE	SIZE 		
77.18.360	RF0762005050	1/2" x 1/2"	10	150
77.18.361	RF0762005070	1/2" x 3/4"	10	100
77.18.362	RF0762007070	3/4" x 3/4"	10	80

STRAIGHT COUPLER SWIVEL NUT

/ RACCORDO DIRITTO DADO PRIGIONIERO
/ ROHRVERSCHRAUBUNG GERADE ÜBERWURFMUTTER
/ MANCHON ÉGAL ÉCROU PRISONNIER



770

CODE	TECH. CODE	SIZE 		
77.18.350	RF0770005050	1/2" x 1/2"	10	150
77.18.351	RF0770007070	3/4" x 3/4"	10	80
77.18.352	RF0770010070	1" x 3/4"	10	70
77.18.353	RF0770010100	1" x 1"	10	70

THREADED FITTINGS 3 PCS

/ RACCORDI FILETTATI 3 PEZZI
/ GEWINDEFITTINGE 3 STK.
/ RACCORDS FILETÉS 3 PIÈCES

BRASS

UNI EN 12164/12165
CW 617N
DIN 50930-6



KIT CONNECTION NUT-TAIL PIECE-FLAT SEAL

/ KIT DADO-CODOLO-GUARNIZIONE PIATTA
/ VERSCHRAUBUNG MUTTER-TÜLLE-
FLACHDICHTUNG
/ KIT COUDE-BOUCHON-JOINT PLAT



245

CODE	TECH. CODE	SIZE	SIZE	
77.10.101	RF0245003000	1/2" F	3/8" M	150
77.10.111	RF0245005000	3/4" F	1/2" M	100
77.10.116	RF0245007000	1" F	3/4" M	50
77.10.121	RF0245010000	1 1/4" F	1" M	50
77.10.126	RF0245012000	1 1/2" F	1 1/4" M	50
77.10.127	RF0245015000	2" F	1 1/2" M	50

FEMALE/MALE STRAIGHT COUPLER METALLIC SEAL

/ BOCCHETTONE DIRITTO FEMMINA/MASCHIO
TENUTA METALLICA
/ ROHRVERSCHRAUBUNG GERADE IG/AG
METALLISCHDICHTEND
/ UNION FEMELLE/MÂLE JOINT MÉTALLIQUE



126

CODE	TECH. CODE	SIZE		
77.09.005	RT0126003MT0	3/8" x 3/8"	10	120
77.09.010	RT0126005MT0	1/2" x 1/2"	10	100
77.09.015	RT0126007MT0	3/4" x 3/4"	10	70
77.09.020	RT0126010MT0	1" x 1"	5	35
77.09.025	RT0126012MT0	1 1/4" x 1 1/4"		15

FEMALE/MALE STRAIGHT COUPLER WITH O-RING TAPERED

/ BOCCHETTONE DIRITTO FEMMINA/MASCHIO
TENUTA O-RING CONICA
/ ROHRVERSCHRAUBUNG GERADE IG/AG MIT
O-RING KONISCH DICHTEND
/ UNION FEMELLE/MÂLE AVEC O-RING
CONIQUE



126

CODE	TECH. CODE	SIZE		
77.09.050	RT0126003000	3/8" x 3/8"	10	120
77.09.055	RT0126005000	1/2" x 1/2"	10	100
77.09.060	RT0126007000	3/4" x 3/4"	10	70
77.09.065	RT0126010000	1" x 1"	5	35
77.09.070	RT0126012000	1 1/4" x 1 1/4"		15
77.09.075	RT0126015000	1 1/2" x 1 1/2"		10
77.09.080	RT0126020000	2" x 2"		10

FEMALE/MALE STRAIGHT COUPLER FLAT SEAL

/ BOCCHETTONE DIRITTO FEMMINA/MASCHIO
TENUTA GUARNIZIONE PIANA
/ ROHRVERSCHRAUBUNG GERADE IG/AG
FLACHDICHTUNG
/ UNION FEMELLE/MÂLE JOINT PLAT



126



CODE	TECH. CODE	SIZE		
77.09.100	RT0126003GU0	3/8" x 3/8"	10	120
77.09.105	RT0126005GU0	1/2" x 1/2"	10	100
77.09.110	RT0126007GU0	3/4" x 3/4"	10	70
77.09.115	RT0126010GU0	1" x 1"	5	30
77.09.120	RT0126012GU0	1 1/4" x 1 1/4"		15
77.09.125	RT0126015GU0	1 1/2" x 1 1/2"		10
77.09.130	RT0126020GU0	2" x 2"		10

**MALE/MALE STRAIGHT COUPLER
METALLIC SEAL**

/ BOCCHETTONE DIRITTO MASCHIO/MASCHIO
TENUTA METALLICA
/ ROHRVERSCHRAUBUNG GERADE AG/AG
METALLISCHDICHTEND
/ UNION MÂLE/MÂLE JOINT MÉTALLIQUE



127



CODE	TECH. CODE	SIZE 		
77.11.005	RT0127003MT0	3/8" x 3/8"	10	150
77.11.010	RT0127005MT0	1/2" x 1/2"	10	100
77.11.015	RT0127007MT0	3/4" x 3/4"	10	60
77.11.020	RT0127010MT0	1" x 1"	5	40
77.11.029	RT0127012MT0	1 1/4" x 1 1/4"		20

**MALE/MALE STRAIGHT COUPLER
WITH O-RING TAPERED**

/ BOCCHETTONE DIRITTO MASCHIO/MASCHIO
TENUTA O-RING CONICA
/ ROHRVERSCHRAUBUNG GERADE AG/AG MIT
O-RING KONISCH DICHTEND
/ UNION MÂLE/MÂLE AVEC O-RING CONIQUE



127



CODE	TECH. CODE	SIZE 		
77.11.050	RT0127003000	3/8" x 3/8"	10	120
77.11.055	RT0127005000	1/2" x 1/2"	10	100
77.11.060	RT0127007000	3/4" x 3/4"	10	60
77.11.065	RT0127010000	1" x 1"	5	40
77.11.074	RT0127012000	1 1/4" x 1 1/4"		20

MALE/MALE STRAIGHT COUPLER FLAT SEAL

/ BOCCHETTONE DIRITTO MASCHIO/MASCHIO
TENUTA GUARNIZIONE PIANA
/ ROHRVERSCHRAUBUNG GERADE AG/AG
FLACHDICHTUNG
/ UNION MÂLE/MÂLE JOINT PLAT



127



CODE	TECH. CODE	SIZE 		
77.11.105	RT0127005GU0	1/2" x 1/2"	10	80
77.11.110	RT0127007GU0	3/4" x 3/4"	10	60
77.11.115	RT0127010GU0	1" x 1"	5	40

**FEMALE/MALE ELBOW 90°
METALLIC SEAL**

/ BOCCHETTONE GOMITO 90°
FEMMINA/MASCHIO TENUTA METALLICA
/ WINKELVERSCHRAUBUNG 90° IG/AG
METALLISCHDICHTEND
/ UNION COUDE 90° FEMELLE/MÂLE
JOINT MÉTALLIQUE



125



CODE	TECH. CODE	SIZE 		
77.10.005	RT0125003MT0	3/8" x 3/8"	10	100
77.10.010	RT0125005MT0	1/2" x 1/2"	10	60
77.10.015	RT0125007MT0	3/4" x 3/4"	10	40
77.10.020	RT0125010MT0	1" x 1"	5	20
77.10.025	RT0125012MT0	1 1/4" x 1 1/4"		15

**FEMALE/MALE ELBOW 90°
WITH O-RING TAPERED**

/ BOCCHETTONE GOMITO 90° FEMMINA/MASCHIO
TENUTA O-RING CONICA
/ WINKELVERSCHRAUBUNG 90° IG/AG MIT O-RING
KONISCH DICHTEND
/ UNION COUDE 90° FEMELLE/MÂLE AVEC O-RING
CONIQUE



125



CODE	TECH. CODE	SIZE 		
77.10.050	RT0125003000	3/8" x 3/8"	10	100
77.10.055	RT0125005000	1/2" x 1/2"	10	70
77.10.060	RT0125007000	3/4" x 3/4"	10	40
77.10.065	RT0125010000	1" x 1"	5	20
77.10.070	RT0125012000	1 1/4" x 1 1/4"		15
77.10.075	RT0125015000	1 1/2" x 1 1/2"		10

FEMALE/MALE ELBOW 90° FLAT SEAL

/ BOCCHETTONE GOMITO 90° FEMMINA/MASCHIO
TENUTA GUARNIZIONE PIANA
/ WINKELVERSCHRAUBUNG 90° IG/AG
FLACHDICHTUNG
/ UNION COUDE 90° FEMELLE/MÂLE JOINT PLAT



125

CODE	TECH. CODE	SIZE 		
77.10.105	RT0125005GU0	1/2" x 1/2"	10	60
77.10.110	RT0125007GU0	3/4" x 3/4"	10	40
77.10.115	RT0125010GU0	1" x 1"	5	20
77.10.120	RT0125012GU0	1 1/4" x 1 1/4"		15
77.10.125	RT0125015GU0	1 1/2" x 1 1/2"		10

EXTENSIONS

/ PROLUNGHE
/ HAHNVERLÄNGERUNGEN
/ RALLONGES

BRASS



UNI EN 12164/12165
CW 617N
DIN 50930-6



EXTENSION MALE/FEMALE HEAVY TYPE

/ PROLUNGA MASCHIO/FEMMINA PESANTE
/ HAHNVERLÄNGERUNG AG/IG SCHWERE AUSFÜHRUNG
/ RALLONGE MÂLE/FEMELLE LOURDE



DIN 3523





277 - 3/8"

CODE	TECH. CODE	SIZE  /L		
77.15.005	RF0277003010	3/8" x 10 mm	10	300
77.15.010	RF0277003020	3/8" x 15 mm	10	250
77.15.015	RF0277003030	3/8" x 20 mm	10	200
77.15.016	RF0277003040	3/8" x 25 mm	10	180
77.15.020	RF0277003050	3/8" x 30 mm	10	150
77.15.021	RF0277003070	3/8" x 40 mm	10	120
77.15.025	RF0277003090	3/8" x 50 mm	10	100
77.15.030	RF0277003120	3/8" x 65 mm	10	70
77.15.035	RF0277003150	3/8" x 80 mm	10	60
77.15.040	RF0277003190	3/8" x 100 mm	10	40



277 - 1/2"

CODE	TECH. CODE	SIZE  /L		
77.15.100	RF0277005010	1/2" x 10 mm	10	200
77.15.105	RF0277005020	1/2" x 15 mm	10	150
77.15.110	RF0277005030	1/2" x 20 mm	10	120
77.15.111	RF0277005040	1/2" x 25 mm	10	120
77.15.115	RF0277005050	1/2" x 30 mm	10	100
77.15.116	RF0277005070	1/2" x 40 mm	10	80
77.15.120	RF0277005090	1/2" x 50 mm	10	80
77.15.121	RF0277005110	1/2" x 60 mm	10	70
77.15.125	RF0277005150	1/2" x 80 mm	10	50

277 - 3/4"

CODE	TECH. CODE	SIZE  /L		
77.15.200	RF0277007010	3/4" x 10 mm	10	150
77.15.205	RF0277007020	3/4" x 15 mm	10	120
77.15.210	RF0277007030	3/4" x 20 mm	10	100
77.15.211	RF0277007040	3/4" x 25 mm	10	100
77.15.215	RF0277007050	3/4" x 30 mm	10	80
77.15.216	RF0277007070	3/4" x 40 mm	10	60
77.15.220	RF0277007090	3/4" x 50 mm	10	60
77.15.221	RF0277007110	3/4" x 60 mm	10	50
77.15.225	RF0277007150	3/4" x 80 mm	10	50
77.15.235	RF0277007190	3/4" x 100 mm	10	30



277 - 1"

CODE	TECH. CODE	SIZE  /L		
77.15.300	RF0277010010	1" x 10 mm	5	100
77.15.305	RF0277010020	1" x 15 mm	5	80
77.15.310	RF0277010030	1" x 20 mm	5	60
77.15.311	RF0277010040	1" x 25 mm	5	50
77.15.315	RF0277010050	1" x 30 mm	5	40
77.15.318	RF0277010070	1" x 40 mm	5	30
77.15.320	RF0277010090	1" x 50 mm	5	20
77.15.321	RF0277010110	1" x 60 mm	5	20
77.15.323	RF0277010150	1" x 80 mm	5	20
77.15.330	RF0277010190	1" x 100 mm	5	20



EXTENSION MALE/FEMALE HEAVY TYPE - CHROME PLATED

/ PROLUNGA MASCHIO/FEMMINA PESANTE - CROMATA
 / HAHNVERLÄNGERUNG AG/IG SCHWERE AUSFÜHRUNG - VERCHROMT
 / RALLONGE MÂLE/FEMELLE LOURDE - CHROMÉE



DIN 3523 - CHROME PLATED**277C - 3/8"**

CODE	TECH. CODE	SIZE  /L		
77.17.005	RF027700301C	3/8" x 10 mm	10	300
77.17.010	RF027700302C	3/8" x 15 mm	10	250
77.17.015	RF027700303C	3/8" x 20 mm	10	200
77.17.016	RF027700304C	3/8" x 25 mm	10	180
77.17.020	RF027700305C	3/8" x 30 mm	10	150
77.17.021	RF027700307C	3/8" x 40 mm	10	120
77.17.025	RF027700309C	3/8" x 50 mm	10	100
77.17.030	RF027700312C	3/8" x 65 mm	10	70
77.17.035	RF027700315C	3/8" x 80 mm	10	60
77.17.040	RF027700319C	3/8" x 100 mm	10	40



277C - 1/2"

CODE	TECH. CODE	SIZE  /L		
77.17.100	RF027700501C	1/2" x 10 mm	10	200
77.17.105	RF027700502C	1/2" x 15 mm	10	150
77.17.110	RF027700503C	1/2" x 20 mm	10	120
77.17.111	RF027700504C	1/2" x 25 mm	10	120
77.17.115	RF027700505C	1/2" x 30 mm	10	100
77.17.116	RF027700507C	1/2" x 40 mm	10	80
77.17.120	RF027700509C	1/2" x 50 mm	10	80
77.17.121	RF027700511C	1/2" x 60 mm	10	70
77.17.125	RF027700515C	1/2" x 80 mm	10	50

277C - 3/4"

CODE	TECH. CODE	SIZE  /L		
77.17.200	RF027700701C	3/4" x 10 mm	10	150
77.17.205	RF027700702C	3/4" x 15 mm	10	120
77.17.210	RF027700703C	3/4" x 20 mm	10	100
77.17.211	RF027700704C	3/4" x 25 mm	10	100
77.17.215	RF027700705C	3/4" x 30 mm	10	80
77.17.216	RF027700707C	3/4" x 40 mm	10	60
77.17.220	RF027700709C	3/4" x 50 mm	10	60
77.17.221	RF027700711C	3/4" x 60 mm	10	50
77.17.225	RF027700715C	3/4" x 80 mm	10	50
77.17.235	RF027700719C	3/4" x 100 mm	10	30

277C - 1"









CODE	TECH. CODE	SIZE  /L		
77.17.300	RF027701001C	1" x 10 mm	5	100
77.17.305	RF027701002C	1" x 15 mm	5	80
77.17.310	RF027701003C	1" x 20 mm	5	60
77.17.311	RF027701004C	1" x 25 mm	5	50
77.17.315	RF027701005C	1" x 30 mm	5	40
77.17.318	RF027701007C	1" x 40 mm	5	30
77.17.320	RF027701009C	1" x 50 mm	5	20
77.17.321	RF027701011C	1" x 60 mm	5	20
77.17.323	RF027701015C	1" x 80 mm	5	20
77.17.330	RF027701019C	1" x 100 mm	5	20

EXTENSION MALE/MALE HEAVY TYPE









/ PROLUNGA MASCHIO/MASCHIO PESANTE
 / HAHNVERLÄNGERUNG AG/AG SCHWERE AUSFÜHRUNG
 / RALLONGE MÂLE/MÂLE LOURDE











278 - 1/2"

CODE	TECH. CODE	SIZE  /L			
77.16.010	RF0278005050	1/2" x 30 mm		10	100
77.16.015	RF0278005070	1/2" x 40 mm		10	100
77.16.020	RF0278005090	1/2" x 50 mm		10	70
77.16.025	RF0278005110	1/2" x 60 mm		10	70
77.16.026	RF0278005130	1/2" x 70 mm		10	50
77.16.030	RF0278005150	1/2" x 80 mm		10	50
77.16.031	RF0278005170	1/2" x 90 mm		10	50
77.16.035	RF0278005210	1/2" x 100 mm		10	50
77.16.036	RF0278005230	1/2" x 120 mm		10	50
77.16.040	RF0278005290	1/2" x 150 mm		10	50
77.16.045	RF0278005390	1/2" x 200 mm		10	30

278 - 3/4"

CODE	TECH. CODE	SIZE  /L			
77.16.110	RF0278007050	3/4" x 30 mm		10	200
77.16.115	RF0278007070	3/4" x 40 mm		10	60
77.16.120	RF0278007090	3/4" x 50 mm		10	60
77.16.125	RF0278007110	3/4" x 60 mm		10	60
77.16.126	RF0278007130	3/4" x 70 mm		10	50
77.16.130	RF0278007150	3/4" x 80 mm		10	50
77.16.131	RF0278007170	3/4" x 90 mm		10	50
77.16.135	RF0278007210	3/4" x 100 mm		10	50
77.16.136	RF0278007220	3/4" x 110 mm		10	30
77.16.140	RF0278007290	3/4" x 150 mm		10	30
77.16.145	RF0278007390	3/4" x 200 mm		10	30

278 - 1"

CODE	TECH. CODE	SIZE  /L			
77.16.210	RF0278010050	1" x 30 mm		5	30
77.16.215	RF0278010070	1" x 40 mm		5	80
77.16.220	RF0278010090	1" x 50 mm		5	60
77.16.225	RF0278010110	1" x 60 mm		5	60
77.16.226	RF0278010130	1" x 70 mm		5	50
77.16.230	RF0278010150	1" x 80 mm		5	20
77.16.231	RF0278010170	1" x 90 mm		5	20
77.16.235	RF0278010210	1" x 100 mm		5	20
77.16.236	RF0278010250	1" x 130 mm		5	20
77.16.240	RF0278010290	1" x 150 mm		5	20

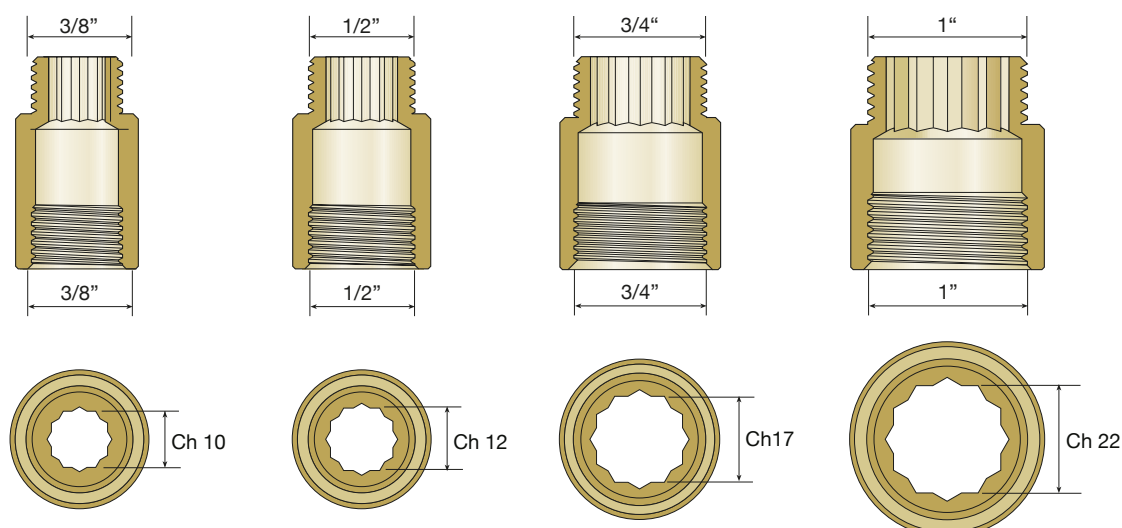
DIMENSIONS / MISURE / ABMESSUNGEN / DIMENSIONS
TECHNICAL SPECIFICATIONS

The Comisa heavy extensions are compatible with:

- UNI EN ISO 228-1:2003 cylindrical male threaded ends
- UNI EN 10226-2:2006 conical male threaded ends
- UNI EN ISO 228-1:2003 female threaded ends

MATERIALS

Brass UNI EN 12164/12168 CW 617 N (DIN 50930-6)

- Suitable for contact with food liquids for human consumption (complies with DIN 3523 standards)
- Hardness HB 2,5/62,5 ≤ 115 (complies with DIN 3523 standards)

HEAT TREATMENT

Normalising.

/ TECHNISCHE EIGENSCHAFTEN

Die Hahnverlängerungen Schwere Ausführung

Comisa passen auf:

- Endstücke mit AG zylindrisch UNI EN ISO 228-1:2003
- Endstücke mit AG konisch UNI EN ISO 10226-2:2006
- Endstücke mit IG UNI EN ISO 228-1:2003

MATERIAL

Messing UNI EN 12164/12168 CW 617 N (DIN 50930-6)

- Für Trinkwasserinstallationen geeignet (entspricht DIN 3523)
- Härte HB 2,5/62,5 ≤ 115 (entspricht DIN 3523)

WÄRMEBEHANDLUNG

Normalglühen.

/ SPECIFICHE TECNICHE

Le prolunghe pesanti Comisa sono compatibili con:

- Terminali filettati maschio cilindrici UNI EN ISO 228-1:2003
- Terminali filettati maschio conici UNI EN 10226-2:2006
- Terminali filettati femmina UNI EN ISO 228-1:2003

MATERIALI

Ottone UNI EN 12164/12168 CW 617 N (DIN 50930-6)

- Adatto al contatto con liquidi alimentari destinati al consumo umano (conforme DIN 3523)
- Durezza HB 2,5/62,5 ≤ 115 (conforme DIN 3523)

TRATTAMENTO TERMICO

Normalizzazione

/ CARACTÉRISTIQUES TECHNIQUES

Les rallonges Comisa lourde sont compatibles avec:

- UNI EN ISO 228-1:2003 filetage mâle cylindrique
- UNI EN 10226-2:2006 filetage mâle conique
- UNI EN ISO 228-1:2003 filetage femelle

MATÉRIAUX

Laiton UNI EN 12164/12168 CW 617 N (DIN 50930-6)

- Adapté au contact avec des liquides alimentaires pour la consommation humaine (conforme aux DIN 3523 normes)
- Dureté HB 2,5/62,5 ≤ 115 (conforme à la norme DIN 3523 normes)

TRAITEMENT THERMIQUE

Normalisation.

NON-NORMALISED EXTENSIONS



NON-NORMALISED EXTENSIONS

- Light yellow colour
- HB 2.5/62.5 > 115 Hardness (does not comply with DIN 3523 standards)
- Occurrence of fractures if subjected to radial compression by a deformation = 7% of the diameter
- Cracks occur if subjected to radial compression = 400 Kgf

/ PROLUNGHE NON NORMALIZZATE

- Colore giallo chiaro
- Durezza HB 2,5/62,5 > 115 (non conforme DIN 3523)
- Sottoposta a schiacciamento radiale per una deformazione = 7% del diametro si assiste alla formazione di fratture
- Sottoposta a schiacciamento radiale = 400 Kgf si producono crepe

/ HAHNVERLÄNGERUNGEN OHNE NORMALGLÜHEN

- Farbe: helles Gelb
- Härte HB 2,5/62,5 > 115 (entspricht nicht DIN 3523)
- Bei einem Radialquetschen mit einer Verformung = 7% des Durchmessers entstehen Brüche
- Bei einem Radialquetschen = 400 Kgf entstehen Risse

/ RALLONGES NON NORMALISÉES

- Couleur jaune pâle
- HB 2.5/62.5 > 115 Dureté (non conformes aux normes DIN 3523)
- Présence de fractures s'elle est soumise à une compression radiale par une déformation = 7% du diamètre
- Les fissures se produisent si soumise à une compression radiale = 400 Kgf

NORMALISED EXTENSIONS



NORMALISED EXTENSIONS

- Dark yellow colour
- HB 2.5/62.5 ≤ 115 Hardness (complies with DIN 3523)
- No fractures if subjected to radial compression by a deformation > 7% of the diameter
- No cracks occur if subjected to radial compression > 400 Kgf (plastic deformation)

/ PROLUNGHE NORMALIZZATE

- Colore giallo intenso
- Durezza HB 2,5/62,5 ≤ 115 (conforme DIN 3523)
- Sottoposta a schiacciamento radiale per una deformazione > 7% del diametro non si assiste alla formazione di fratture
- Sottoposta a schiacciamento radiale > 400 Kgf non si producono crepe (deformazione plastica)

/ NORMALGEGLÜHTE HAHNVERLÄNGERUNGEN

- Farbe: leuchtendes Gelb
- Härte HB 2,5/62,5 ≤ 115 (entspricht DIN 3523)
- Bei einem Radialquetschen mit einer Verformung > 7% des Durchmessers entstehen keine Brüche
- Bei einem Radialquetschen > 400 Kgf entstehen keine Risse (zähe Verformung)

/ RALLONGES NORMALISÉES

- Couleur jaune foncé
- HB 2.5/62.5 ≤ 115 Dureté (selon DIN 3523)
- Pas de fractures si soumise à une compression radiale par une déformation > 7% du diamètre
- Pas de fissures si soumise à une compression radiale > 400 Kgf (déformation plastique)

EFFECTS OF THERMAL TREATMENT ON THE BRASS ALLOYS

Mechanical operations required to obtain the product (fitting) causes hardening thereof and the ensuing increase of fragility. This problem can be overcome through suitable heat treatment.

Heating the fittings at a given temperature over a preset period of time allows softening the product.

When normalising an alloy, crystals deformed and subjected to stress are transformed into stress-free crystals through resetting, re-crystallisation and grain growth.

Normalised fittings have a higher capacity of absorbing deformations without being exposed to the risk of breakage, while the aesthetic aspect varies considerably in terms of colour.

/ AUSWIRKUNGEN DER WÄRMBEHANDLUNG AUF DIE MESSINGLEGIERUNGEN

Die für die Entstehung des Werkstücks (Fitting) notwendige mechanische Bearbeitung führt zur Verfestigung und somit zu einer erhöhten Brüchigkeit, der man mit einer entsprechenden Wärmebehandlung begegnen kann.

Wird das Fitting für eine vorher festgelegte Zeit bis zu einer bestimmten Temperatur erhitzt, führt dies zu einer Erweichung des Werkstücks.

Beim Normalglühen einer Legierung werden die verformten und unter Spannung stehenden Kristalle mittels Versetzung, Rekristallisation und Kornwachstum in Kristalle ohne Spannung umgewandelt.

Durch das Normalglühen erhöht sich die bruchfreie Verformbarkeit des Werkstücks, wobei durch die Behandlung eine signifikante farbliche Veränderung auftritt.

/ EFFETTI DEI TRATTAMENTI TERMICI SULLE LEGHE DI OTTONE

Le lavorazioni meccaniche necessarie per ottenere il manufatto (raccordo) ne causano l'incrudimento ed il conseguente aumento della fragilità: vi si può ovviare mediante appropriato trattamento termico.

Attraverso il riscaldamento dei raccordi ad una certa temperatura per un tempo prefissato si ottiene un ammorbidimento del manufatto.

Durante la normalizzazione di una lega, i cristalli deformati e sotto sforzo sono trasformati in cristalli privi di tensioni attraverso riassetto, ricristallizzazione e crescita dei grani.

Nel raccordo normalizzato aumenta la capacità di assorbire deformazioni senza il rischio di rotture; l'aspetto estetico presenta una significativa variazione della colorazione.

/ EFFETS DE TRAITEMENT THERMIQUE SUR LES ALLIAGES DE LAITON

L'usinage nécessaire pour obtenir l'extension provoque un durcissement du laiton ce qui le rend plus fragile.

Ce défaut peut être corrigé par un traitement thermique approprié.

Lors du traitement thermique de normalisation d'un alliage, des cristaux déformés et soumis à des tensions internes se réorganisent afin de réduire les tensions internes et recristalliser.

Les raccords normalisés ont une plus grande capacité de supporter les déformations sans risque de cassure. Ils sont facilement reconnaissables à leur couleur jaune foncé.

THREADED FITTINGS NICKEL-PLATED

/ RACCORDI FILETTATI NICHELATI
/ GEWINDEFITTINGE VERNICKELT
/ RACCORDS FILETÉS NICHELÉS

BRASS

UNI EN 12164/12165
CW 617N
DIN 50930-6



MALE/MALE STRAIGHT COUPLER

/ RACCORDO DIRITTO MASCHIO/MASCHIO
/ KUPPLUNG AG/AG
/ MANCHON MÂLE/MÂLE



270A

CODE	TECH. CODE	SIZE		
71.01.050	RF0270A0300N	3/8" x 3/8"	10	400
71.01.051	RF0270A0500N	1/2" x 1/2" (Ø int. mm 14 - fil. mm 9)	10	300
71.01.060	RF0270A0514N	1/2" x 1/2" (Ø int. mm 14 - fil. mm 11)	10	200
71.01.014	RF0270A0700N	3/4" x 3/4" (Ø int. mm 19 - fil. mm 10)	10	200
71.01.061	RF0270A0719N	3/4" x 3/4" (Ø int. mm 19 - fil. mm 12)	10	150
71.01.052	RF0270A1000N	1" x 1"	10	100
71.01.053	RF0270A1200N	1 1/4" x 1 1/4"	10	60
71.01.054	RF0270A1500N	1 1/2" x 1 1/2"	5	40
71.01.055	RF0270A2000N	2" x 2"	5	25

HEAVY PATTERN SERIES

MALE/MALE REDUCING COUPLER

/ RACCORDO DIRITTO RIDOTTO
MASCHIO/MASCHIO
/ REDUZIERNIPPEL AG/AG
/ MANCHON RÉDUIT MÂLE/MÂLE



291

CODE	TECH. CODE	SIZE		
71.02.080	RF029100503N	1/2" x 3/8"	10	300
71.02.081	RF029100705N	3/4" x 1/2"	10	200
71.02.082	RF029101007N	1" x 3/4"	10	120
71.02.083	RF029101210N	1 1/4" x 1"	10	80
71.02.084	RF029101512N	1 1/2" x 1 1/4"	5	40
71.02.085	RF029102015N	2" x 1 1/2"		25

MALE/FEMALE REDUCTION

/ RIDUZIONE MASCHIO/FEMMINA
/ REDUZIERTSTÜCK AG/IG
/ RÉDUCTION MÂLE/FEMELLE



287

CODE	TECH. CODE	SIZE		
71.14.172	RF028700501N	1/2" M x 1/8" F	10	400
71.14.173	RF028700502N	1/2" M x 1/4" F	10	400
71.14.174	RF028700503N	1/2" M x 3/8" F	10	400
71.14.175	RF028700705N	3/4" M x 1/2" F	10	300
71.14.177	RF028701005N	1" M x 1/2" F	10	200
71.14.178	RF028701007N	1" M x 3/4" F	10	200
71.14.179	RF028701207N	1 1/4" M x 3/4" F	10	100
71.14.180	RF028701210N	1 1/4" M x 1" F	10	100
71.14.183	RF028701512N	1 1/2" M x 1 1/4" F	10	70
71.14.184	RF028702015N	2" M x 1 1/2" F		30

FEMALE/FEMALE STRAIGHT COUPLER

/ RACCORDO DIRITTO FEMMINA/FEMMINA
/ MUFFE IG/IG
/ MANCHON FEMELLE/FEMELLE



270F

CODE	TECH. CODE	SIZE		
71.03.041	RF0270F0300N	3/8" x 3/8"	10	300
71.03.046	RF0270F0500N	1/2" x 1/2"	10	200
71.03.047	RF0270F0700N	3/4" x 3/4"	10	100
71.03.042	RF0270F1000N	1" x 1"	10	70
71.03.043	RF0270F1200N	1 1/4" x 1 1/4"	10	40
71.03.044	RF0270F1500N	1 1/2" x 1 1/2"	5	20
71.03.045	RF0270F2000N	2" x 2"	5	15

MALE PLUG WITH FLANGE

/ TAPPO MASCHIO CON FLANGIA
/ STOPFEN AG MIT FLANSCH
/ BOUCHON MÂLE AVEC BRIDE D'ARRÊT



276

CODE	TECH. CODE	SIZE		
71.13.040	RF027600500N	1/2"	10	350
71.13.041	RF027600700N	3/4"	10	200
71.13.042	RF027601000N	1"	10	120

FEMALE/MALE REDUCING COUPLER

/ RACCORDO DIRITTO RIDOTTO
FEMMINA/MASCHIO
/ MUFFE IG/AG REDUZIERT
/ MANCHON RÉDUIT FEMELLE/MÂLE

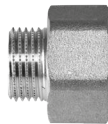

295

CODE	TECH. CODE	SIZE		
71.04.073	RF029500503N	1/2" F x 3/8" M	10	250
71.04.070	RF029500705N	3/4" F x 1/2" M	10	150
71.04.071	RF029501005N	1" F x 1/2" M	10	80
71.04.072	RF029501007N	1" F x 3/4" M	10	80

FEMALE/FEMALE REDUCING COUPLER

/ RACCORDO DIRITTO RIDOTTO
FEMMINA/FEMMINA
/ MUFFE IG/IG REDUZIERT
/ MANCHON RÉDUIT FEMELLE/FEMELLE



294

CODE	TECH. CODE	SIZE		
71.03.091	RF029400705N	3/4" x 1/2"	10	120
71.03.092	RF029401005N	1" x 1/2"	10	70
71.03.093	RF029401007N	1" x 3/4"	10	70
71.03.094	RF029401210N	1 1/4" x 1"	5	40

FEMALE/FEMALE ELBOW 90°

/ GOMITO 90° FEMMINA/FEMMINA
/ WINKEL 90° IG/IG
/ COUDE 90° FEMELLE/FEMELLE



260F

CODE	TECH. CODE	SIZE		
71.05.041	RF0260F0300N	3/8" x 3/8"	10	200
71.05.042	RF0260F0500N	1/2" x 1/2"	10	130
71.05.043	RF0260F0700N	3/4" x 3/4"	10	70
71.05.044	RF0260F1000N	1" x 1"	5	40
71.05.045	RF0260F1200N	1 1/4" x 1 1/4"		20
71.05.046	RF0260F1500N	1 1/2" x 1 1/2"		20
71.05.047	RF0260F2000N	2" x 2"		15

MALE/MALE ELBOW 90°

/ GOMITO 90° MASCHIO/MASCHIO
/ WINKEL 90° AG/AG
/ COUDE 90° MÂLE/MÂLE



260A

CODE	TECH. CODE	SIZE		
71.07.038	RF0260A0500N	1/2" x 1/2"	10	200
71.07.039	RF0260A0700N	3/4" x 3/4"	10	120
71.07.040	RF0260A1000N	1" x 1"	10	50

FEMALE/MALE ELBOW 90°

/ GOMITO 90° FEMMINA/MASCHIO
/ WINKEL 90° IG/AG
/ COUDE 90° FEMELLE/MÂLE



262A

CODE	TECH. CODE	SIZE		
71.06.036	RF0262A0300N	3/8" x 3/8"	10	200
71.06.037	RF0262A0500N	1/2" x 1/2"	10	120
71.06.038	RF0262A0700N	3/4" x 3/4"	10	40
71.06.039	RF0262A1000N	1" x 1"	10	40
71.06.040	RF0262A1200N	1 1/4" x 1 1/4"		25
71.06.041	RF0262A1500N	1 1/2" x 1 1/2"		20
71.06.042	RF0262A2000N	2" x 2"		15

FEMALE/MALE REDUCING ELBOW 90°

/ GOMITO 90° RIDOTTO FEMMINA/MASCHIO
/ WINKEL 90° IG/AG REDUZIERT
/ COUDE RÉDUIT 90° FEMELLE/MÂLE 90°



262B

CODE	TECH. CODE	SIZE		
71.06.050	RF0262B0503N	1/2" x 3/8"	10	150
71.06.051	RF0262B0705N	3/4" x 1/2"	10	100

FEMALE/MALE EXTENSION

/ PROLUNGA FEMMINA/MASCHIO
/ VERLÄNGERUNG IG/AG
/ RALLONGE FEMELLE/MÂLE

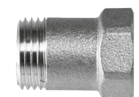

292

CODE	TECH. CODE	SIZE		
71.15.150	RF029200510N	1/2" - 10	10	250
71.15.151	RF029200515N	1/2" - 15	10	250
71.15.152	RF029200520N	1/2" - 20	10	200
71.15.153	RF029200525N	1/2" - 25	10	200
71.15.154	RF029200530N	1/2" - 30	10	150

FEMELLE/FEMELLE WALLPLATE ELBOW 90°

/ GOMITO 90° FLANGIATO FEMMINA/FEMMINA
/ WANDWINKEL 90° IG/IG
/ APPLIQUE MURALE 90° FEMELLE/FEMELLE



264F

CODE	TECH. CODE	SIZE		
71.08.100	RF0264F0500N	1/2" x 1/2"	10	100

MALE TEE

/ RACCORDO A T MASCHIO
/ T-STÜCK MIT AG
/ TÉ MÂLE



250A

CODE	TECH. CODE	SIZE		
71.07.094	RF0250A0500N	1/2" x 1/2" x 1/2"	10	120
71.07.095	RF0250A0700N	3/4" x 3/4" x 3/4"	10	80
71.07.096	RF0250A1000N	1" x 1" x 1"	5	40

FEMALE TEE

/ RACCORDO A T FEMMINA
/ T-STÜCK MIT IG
/ TÉ FEMELLE



250F

CODE	TECH. CODE	SIZE		
71.08.039	RF0250F0500N	1/2" x 1/2" x 1/2"	10	80
71.08.040	RF0250F0700N	3/4" x 3/4" x 3/4"	10	50
71.08.041	RF0250F1000N	1" x 1" x 1"	5	25
71.08.042	RF0250F1200N	1 1/4" x 1 1/4" x 1 1/4"		15
71.08.043	RF0250F1500N	1 1/2" x 1 1/2" x 1 1/2"		15
71.08.044	RF0250F2000N	2" x 2" x 2"		15

REDUCING TEE FEMALE

/ RACCORDO A T RIDOTTO FEMMINA
/ T-STÜCK REDUZIERT IG
/ TÉ RÉDUIT FEMELLE



253F

CODE	TECH. CODE	SIZE		
71.08.050	RF0253F0705N	3/4" x 1/2" x 3/4"	10	50

FEMALE CAP

/ TAPPO FEMMINA
/ KAPPE IG
/ BOUCHON FEMELLE

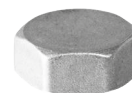

288

CODE	TECH. CODE	SIZE		
71.12.006	RF028800300N	3/8"	10	400
71.12.010	RF028800500N	1/2"	10	400
71.12.015	RF028800700N	3/4"	10	250
71.12.020	RF028801000N	1"	10	120
71.12.026	RF028801200N	1" 1/4"	10	100
71.12.031	RF028801500N	1" 1/2"	5	50

MALE CAP

/ TAPPO MASCHIO
/ STOPFEN AG
/ BOUCHON MÂLE



286

CODE	TECH. CODE	SIZE		
71.13.043	RF028600300N	3/8"	10	400
71.13.044	RF028600500N	1/2"	10	400
71.13.045	RF028600700N	3/4"	10	150
71.13.046	RF028601000N	1"	10	150
71.13.047	RF028601200N	1 1/4"	10	80
71.13.048	RF028601500N	1 1/2"	10	60
71.13.049	RF028602000N	2"	5	40

HEAVY PATTERN SERIES

MALE/FEMALE ELBOW 90° WITH FLANGE - HP SERIES

/ GOMITO 90° MASCHIO/FEMMINA CON FLANGIA - SERIE HP
/ WINKEL 90° AG/IG MIT FLANSCH - HP SERIE
/ COUDE 90° MÂLE/FEMELLE AVEC BRIDE D'ARRÊT - HP SERIE



267

CODE	TECH. CODE	SIZE		
71.06.020	RF026700500N	1/2" x 1/2"	10	100
71.06.025	RF026700700N	3/4" x 3/4"	10	100
71.06.030	RF026701000N	1" x 1"	5	50

THREADED FITTINGS NICKEL-PLATED 3 PCS



/ RACCORDI FILETTATI NICHELATI 3 PEZZI
 / GEWINDEFITTINGE VERNICKELT 3 STK.
 / RACCORDS FILETÉS NICHELÉS 3 PIÈCES

FEMALE/MALE ELBOW 90° WITH O-RING TAPERED

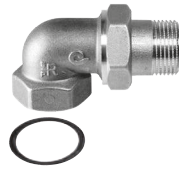
/ BOCCHETTONE GOMITO 90° FEMMINA/MASCHIO
 TENUTA O-RING CONICA
 / WINKELVERSCHRAUBUNG 90° IG/AG MIT O-RING
 KONISCH DICHTEND
 / UNION COUDE FEMELLE/MÂLE 90° AVEC O-RING
 CONIQUE



125



CODE	TECH. CODE	SIZE 		
71.10.050	RT012500300N	3/8" x 3/8"	10	100
71.10.055	RT012500500N	1/2" x 1/2"	10	70
71.10.060	RT012500700N	3/4" x 3/4"	10	40
71.10.065	RT012501000N	1" x 1"	5	20
71.10.070	RT012501200N	1 1/4" x 1 1/4"		15

FEMALE/MALE ELBOW 90° FLAT SEAL

/ BOCCHETTONE GOMITO 90° FEMMINA/MASCHIO
 TENUTA GUARNIZIONE PIANA
 / WINKELVERSCHRAUBUNG 90° IG/AG
 FLACHDICHTUNG
 / UNION COUDE FEMELLE/MÂLE 90° JOINT PLAT



125



CODE	TECH. CODE	SIZE 		
71.10.105	RT0125005GUN	1/2" x 1/2"	10	70
71.10.110	RT0125007GUN	3/4" x 3/4"	10	40
71.10.115	RT0125010GUN	1" x 1"	5	20

FEMALE/MALE STRAIGHT COUPLER WITH O-RING TAPERED

/ BOCCHETTONE DIRITTO FEMMINA/MASCHIO
 TENUTA O-RING CONICA
 / ROHRVERSCHRAUBUNG GERADE IG/AG MIT
 O-RING KONISCH DICHTEND
 / UNION FEMELLE/MÂLE AVEC O-RING
 CONIQUE



126



CODE	TECH. CODE	SIZE 		
71.09.050	RT012600300N	3/8" x 3/8"	10	120
71.09.055	RT012600500N	1/2" x 1/2"	10	100
71.09.060	RT012600700N	3/4" x 3/4"	10	70
71.09.065	RT012601000N	1" x 1"	5	35
71.09.070	RT012601200N	1 1/4" x 1 1/4"		15

FEMALE/MALE STRAIGHT COUPLER FLAT SEAL

/ BOCCHETTONE DIRITTO FEMMINA/MASCHIO
 TENUTA GUARNIZIONE PIANA
 / ROHRVERSCHRAUBUNG GERADE IG/AG
 FLACHDICHTUNG
 / UNION FEMELLE/MÂLE JOINT PLAT



126



CODE	TECH. CODE	SIZE 		
71.09.105	RT0126005GUN	1/2" x 1/2"	10	100
71.09.110	RT0126007GUN	3/4" x 3/4"	10	70
71.09.115	RT0126010GUN	1" x 1"	5	35

MALE/MALE STRAIGHT COUPLER WITH O-RING TAPERED

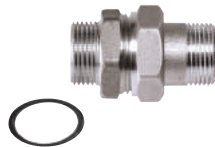
/ BOCCHETTONE DIRITTO MASCHIO/MASCHIO
 TENUTA O-RING CONICA
 / ROHRVERSCHRAUBUNG GERADE AG/AG MIT
 O-RING KONISCH DICHTEND
 / UNION MÂLE/MÂLE AVEC O-RING CONIQUE



127



CODE	TECH. CODE	SIZE 		
71.11.050	RT012700300N	3/8" x 3/8"	10	120
71.11.055	RT012700500N	1/2" x 1/2"	10	80
71.11.060	RT012700700N	3/4" x 3/4"	10	60
71.11.065	RT012701000N	1" x 1"	5	30
71.11.074	RT012701200N	1 1/4" x 1 1/4"		20

MALE/MALE STRAIGHT COUPLER FLAT SEAL

/ BOCCHETTONE DIRITTO MASCHIO/MASCHIO
 TENUTA GUARNIZIONE PIANA
 / ROHRVERSCHRAUBUNG GERADE AG/AG
 FLACHDICHTUNG
 / UNION MÂLE/MÂLE JOINT PLAT



127

CODE	TECH. CODE	SIZE 		
71.11.105	RT0127005GUN	1/2" x 1/2"	10	80
71.11.110	RT0127007GUN	3/4" x 3/4"	10	60
71.11.115	RT0127010GUN	1" x 1"	5	30

THREADED FITTINGS CHROME-PLATED



/ RACCORDI FILETTATI CROMATI
/ GEWINDEFITTINGE VERCHROMT
/ RACCORDS FILETÉS CHROMÉS

MALE/MALE STRAIGHT COUPLER

/ RACCORDO DIRITTO MASCHIO/MASCHIO
/ KUPPLUNG AG/AG
/ MANCHON MÂLE/MÂLE



270A



CODE	TECH. CODE	SIZE 		
77.21.050	RF0270A0300C	3/8" x 3/8"	10	400
77.21.060	RF0270A0514C	1/2" x 1/2" (Ø int. mm 14 - fil. mm 11)	10	200
77.21.061	RF0270A0719C	3/4" x 3/4" (Ø int. mm 19 - fil. mm 12)	10	150

FEMALE/FEMALE STRAIGHT COUPLER

/ RACCORDO DIRITTO FEMMINA/FEMMINA
/ MUFFE IG/IG
/ MANCHON FEMELLE/FEMELLE



270F



CODE	TECH. CODE	SIZE 		
77.23.040	RF0270F0200C	1/4" x 1/4"	10	500
77.23.041	RF0270F0300C	3/8" x 3/8"	10	300
77.23.046	RF0270F0500C	1/2" x 1/2"	10	200
77.23.047	RF0270F0700C	3/4" x 3/4"	10	100

MALE/FEMALE REDUCTION

/ RIDUZIONE MASCHIO/FEMMINA
/ REDUZIERTSTÜCK AG/IG
/ RÉDUCTION MÂLE/FEMELLE



287



CODE	TECH. CODE	SIZE 		
77.24.171	RF028700302C	3/8" M x 1/4" F	10	500
77.24.173	RF028700502C	1/2" M x 1/4" F	10	400
77.24.174	RF028700503C	1/2" M x 3/8" F	10	400
77.24.175	RF028700705C	3/4" M x 1/2" F	10	300

MALE/MALE REDUCING COUPLER

/ RACCORDO DIRITTO RIDOTTO
MASCHIO/MASCHIO
/ REDUZIERNIPPEL AG/AG
/ MANCHON RÉDUIT MÂLE/MÂLE



291

CODE	TECH. CODE	SIZE 		
77.22.080	RF029100503C	1/2" x 3/8"	10	300
77.22.081	RF029100705C	3/4" x 1/2"	10	200



HEAVY PATTERN SERIES

MALE/FEMALE ELBOW 90° WITH FLANGE - HP SERIES

/ GOMITO 90° MASCHIO/FEMMINA CON FLANGIA - SERIE HP
/ WINKEL 90° AG/IG MIT FLANSCH - HP SERIE
/ COUDE 90° MÂLE/FEMELLE AVEC BRIDE D'ARRÊT - HP SERIE



267

CODE	TECH. CODE	SIZE 		
77.26.020	RF026700500C	1/2" x 1/2"	10	100
77.26.025	RF026700700C	3/4" x 3/4"	10	100

FEMALE/MALE REDUCING COUPLER

/ RACCORDO DIRITTO RIDOTTO
 / FEMMINA/MASCHIO
 / MUFFE IG/AG REDUZIERT
 / MANCHON RÉDUIT FEMELLE/MÂLE



295

CODE	TECH. CODE	SIZE		
77.24.073	RF029500503C	1/2" F x 3/8" M	10	250
77.24.070	RF029500705C	3/4" F x 1/2" M	10	150

FEMALE/FEMALE REDUCING COUPLER

/ RACCORDO DIRITTO RIDOTTO
 / FEMMINA/FEMMINA
 / MUFFE IG/IG REDUZIERT
 / MANCHON RÉDUIT FEMELLE/FEMELLE



294

CODE	TECH. CODE	SIZE		
77.23.091	RF029400705C	3/4" x 1/2"	10	120

FEMALE TEE

/ RACCORDO A T FEMMINA
 / T-STÜCK MIT IG
 / TÉ FEMELLE



250F

CODE	TECH. CODE	SIZE		
77.28.037	RF0250F0200C	1/4" x 1/4" x 1/4"	10	200
77.28.038	RF0250F0300C	3/8" x 3/8" x 3/8"	10	150
77.28.039	RF0250F0500C	1/2" x 1/2" x 1/2"	10	80
77.28.040	RF0250F0700C	3/4" x 3/4" x 3/4"	10	50

MALE/MALE ELBOW 90°

/ GOMITO 90° MASCHIO/MASCHIO
 / WINKEL 90° AG/AG
 / COUDE 90° MÂLE/MÂLE



260A

CODE	TECH. CODE	SIZE		
77.27.036	RF0260A0200C	1/4" x 1/4"	10	400
77.27.037	RF0260A0300C	3/8" x 3/8"	10	300
77.27.038	RF0260A0500C	1/2" x 1/2"	10	200
77.27.039	RF0260A0700C	3/4" x 3/4"	10	120

FEMALE/FEMALE ELBOW 90°

/ GOMITO 90° FEMMINA/FEMMINA
 / WINKEL 90° IG/IG
 / COUDE 90° FEMELLE/FEMELLE



260F

CODE	TECH. CODE	SIZE		
77.25.040	RF0260F0200C	1/4" x 1/4"	10	300
77.25.041	RF0260F0300C	3/8" x 3/8"	10	200
77.25.042	RF0260F0500C	1/2" x 1/2"	10	130
77.25.043	RF0260F0700C	3/4" x 3/4"	10	70

MALE/MALE ELBOW 90°

/ GOMITO 90° MASCHIO/MASCHIO
 / WINKEL 90° AG/AG
 / COUDE 90° MÂLE/MÂLE



262A

CODE	TECH. CODE	SIZE		
77.26.035	RF0262A0200C	1/4" x 1/4"	10	200
77.26.036	RF0262A0300C	3/8" x 3/8"	10	200
77.26.037	RF0262A0500C	1/2" x 1/2"	10	120
77.26.038	RF0262A0700C	3/4" x 3/4"	10	40



COMISA S.p.A. - Via Neziole, 27 - 25055 Pisogne - BS - ITALY

SPR AND RAVANI ARE BRANDS OF COMISA S.P.A. - ORGANIZATION, MANAGEMENT AND CONTROL MODEL PURSUANT TO ITALIAN LEGISLATIVE DECREE 231/01